

FCX4000 SERIES

CUTTING PLOTTER

SETUP MANUAL

MANUAL NO. FCX4000-UM-8M1

Preface

Thank you for choosing this product. Carefully keep this manual in a handy location for quick reference as necessary prior to use to ensure safe and correct use and also to thoroughly understand the functions and operate them effectively.

Prior to use

Be sure to read the attached "TO ENSURE SAFE AND CORRECT USE" prior to use. Otherwise, it may cause an unexpected accident or fire.

Notes on this Manual

- (1) No part of this publication may be reproduced, stored in a retrieval system, or transmitted, in any form or by any means, without the prior written permission of Graphtec Corporation.
- (2) The product specifications and other information in this manual are subject to change without notice.
- (3) While every effort has been made to provide complete and accurate information, please contact your sales representative or nearest Graphtec vendor if you find any unclear or erroneous information or wish to make other comments or suggestions.
- (4) Notwithstanding the stipulations in the preceding paragraph, Graphtec Corporation assumes no liability for damages resulting from either the use of the information contained herein or the use of the product.

Registered Trademarks

All names of companies, brands, logotypes, and products appearing in this manual are the trademarks or registered trademarks of their respective companies.

Copyright

This User's Manual is copyrighted by Graphtec Corporation.

Roles of each manual

- Setup Manual (this manual)Read it to understand displaying method for the User's Manual, method for connecting this Cutting Plotter with the PC, installing method for driver software, and to prepare for the operation.
- User's Manual (PDF data)Read it to thoroughly understand the functions.

※ P.00 indicates reference page in this Setup Manual.

Before starting the Setup

Make the following preparations before starting Setup.

- Check that all of the items included in the package. (Please see in the User's Manual (PDF).
For the Parts Names, please see in the User's Manual (PDF).
- To use the Cutting Master 4, previously install the design application (Adobe Illustrator or CorelDraw) that is used.
For the latest supported version, please visit our website.
- When there are virus detection program or system resident program, terminate them beforehand.
- Upon installation, be sure to log in Windows/Macintosh using an account with administrator privileges on your computer.

Setup flow

Setting up the Plotter main unit

1. Attaching a Tool	The cutter blade can be replaced depending on the material or thickness of the media.	P.03
2. Loading the Media	Set up the media in the Plotter.	P.04
3. About the Initial Setup screen	Select "Display Language" and "Length Unit".	P.05
4. Tool adjustment and test cutting	Adjust the tip length of the cutter blade and force (pressure to cut) depending on the material or thickness of the media. By cutting to test the set media, it can be adjusted to the optimal condition.	P.05

Installing the Software

• Setup in a Windows operating environment

Launching the Start menu	For each software, install them using the Installer stored in the attached DVD-ROM.	P.07
A. Install FCX4000 Software		
Installing the Driver software (Cutting Plotter Driver)	The Driver software controls the Plotter and makes plotting according to the data created by the PC.	P.09
• To connect using the USB	Turn on the power source of Plotter in the middle of installing, and connect the USB cable.	P.09

Install the software as necessary.

B. Setup the Graphtec Pro Studio	Software enabling cutting data to be created through simple commands. Create designs and edit characters/shapes using this software.	P.11
C. Setup the Cutting Master 4	Plug-in driver that enables simple cutting through direct operation from within Adobe Illustrator and CorelDRAW.	P.11
D. Install the User's Manual	Install the User's Manual.	P.11

• Setup in a Macintosh operating environment

A. Setup the Cutting Master 4	Plug-in driver that enables simple cutting through direct operation from within Adobe Illustrator.	P.12
B. Setup the Graphtec Studio	Software enabling cutting data to be created through simple commands. Create designs and edit characters/shapes using this software.	P.12

Setting up the Plotter main unit

1 Attaching a Tool

Attach a tool to the plotter.

Attaching a Tool

When attaching the tool in the tool holder, please note the following.

- Push the tool all the way into the holder until its flange contacts the upper part of the holder and then tighten the screw firmly.
- To prevent injury, avoid absolutely touching the tool immediately after the cutting plotter is turned on or whenever the tool is moving.

For details, see “Attaching a Tool” in the User’s Manual.

It is explained here using cutter plunger as an example.

- 1 Loosen the tool holder screw.

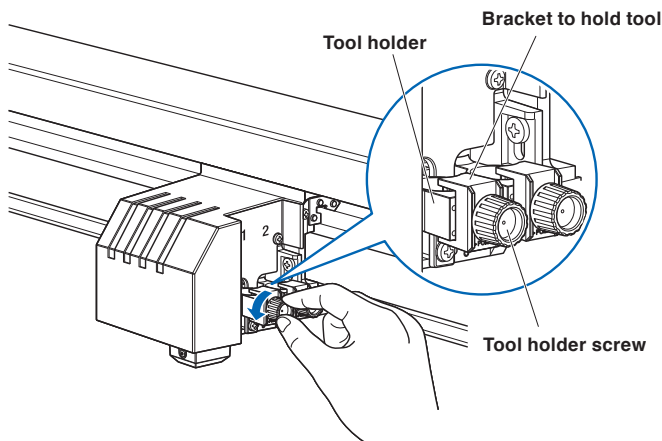

- 2 While pushing up the tool holder, push until the flange of tool completely touches the upper part of the holder.

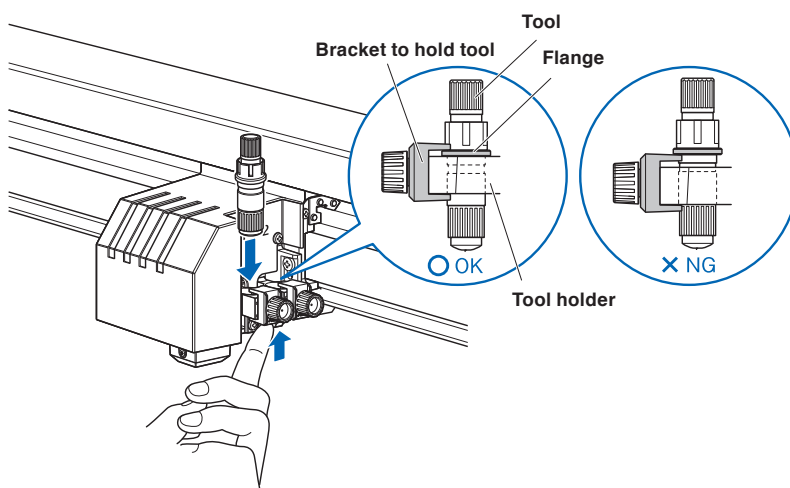

CAUTION

When pushing up the tool holder with your fingers, the blade tip may be protruding. Take care not to cut your fingers.

- 3 Make sure that the tool bracket is engaged on the tool's flange, and then tighten the screw.

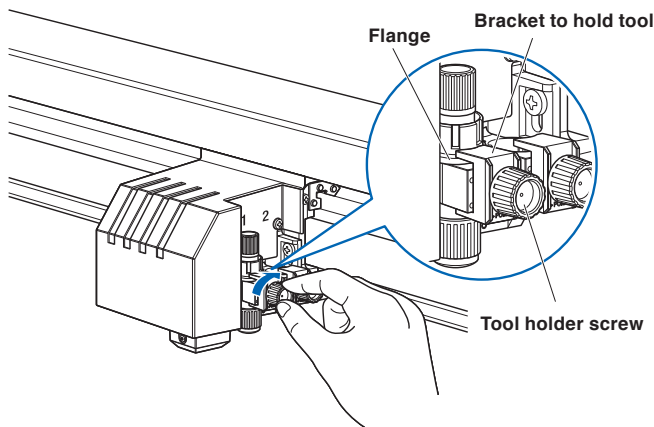

Removing the tool

When removing the tool, turn the tool holder screw counterclockwise to remove the tool.

2 Loading the Media

Supplement

- This plotter is available with a electrostatic writing panel.
- There are media that cannot be held down by any method. Please test before use.
- Antistatic-treated media cannot be held down in electrostatic writing panel.
- If air gets in between the writing panel and the media during loading, force out the air and ensure that the media is securely attached to the writing panel before cutting.
- When cutting a media that doesn't come with a backing sheet on the electrostatic writing panel, spread a vinyl backing sheet or something similar on the panel before cutting. Replacement of damaged writing panel is available for a fee.
- When loading a media that cannot be securely attached on the electrostatic writing panel, reinforce adhesion by using tape on all four sides.
- When using the electrostatic writing panel, do not use a spray glue and a spray glue remover directly on the writing panel.
- When the media is changed to a different type, we recommend that you perform the registration mark sensor sensitivity adjustment. (See "Adjusting the Sensor Level" in the User's Manual (PDF).)

How to Load the media

- (1) Make sure that the [CHART HOLD] key is turned off.
- (2) Place the media on the writing panel.
- (3) Press the [CHART HOLD] key (to hold-down the media) next to the control panel.
- (4) The green [CHART HOLD] key lamp (to hold-down the media) lights to indicate that the media is being held by electrostatic adhesion.

Supplement

Press the [CHART HOLD] key (to hold-down the media) again to release the electrostatic adhesion. The green lamp will not be lit.

It may take some time to be able to hold-down the media by pressing the [CHART HOLD] key (to hold-down the media) depending on operating environment.

After the media has been held for a while by electrostatic adhesion, it may become charged with static electricity and therefore be harder to remove from the writing panel. There is nothing abnormal about this phenomenon.

3 About the Initial Setup screen

The Initial Setup Screen appears only when powering up the machine for the first time after purchase. Here, you can set the display language and length unit.

You can also change the settings from the menu after a setup.

(See “Display Language Settings (Language)” and “Display Length Unit Settings (Length Unit)” in the User’s Manual (PDF).)

See “Connecting to the Power Supply” in the User’s Manual (PDF) for turning on the power.

- 1 Once the machine is powered on ("I" side) a message will be displayed after the version will be displayed.

▶ Here, DISPLAY LANGUAGE setting screen is displayed.



- 2 Use the POSITION (◀▶▲▼) keys to select the language.
(You can also change the settings from the menu after a setup.)
- 3 Press the [ENTER] key.

▶ After the DISPLAY LANGUAGE is selected, the LENGTH UNIT screen will appear.

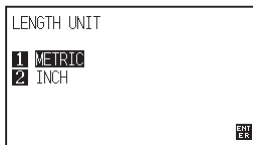

- 4 Press the [1] key (METRIC) or the [2] key (INCH) to select the length unit setting.
- 5 Confirm the setting and press the [ENTER] key.
▶ Setting will be set, and it will return to default screen.

4 Tool adjustment and test cutting

After setting the Tool/Speed/Force/Acceleration, make test cutting, and repeat until optimal condition is achieved.

- 1 Load the media for test cutting in the plotter.
- 2 Press the [COND/TEST] key in the default screen.
▶ CONDITION setting screen (1/4) is displayed.

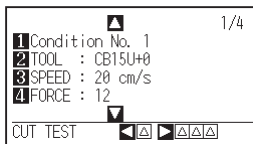

- 3 Set the Tool conditions (Tool, Speed, Force, Acceleration).

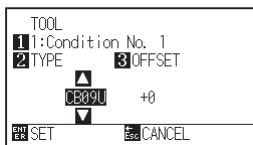

⚠ CAUTION

Do not touch the Tool tip when power is turned on or during operation.

Setting the Tool conditions

See “Selecting Tool Condition” in the User’s Manual (PDF) for more information on how to set the various cutting conditions.

To make 1 cut with set value

- 4 Make test cutting for one piece while Tool conditions are being set.

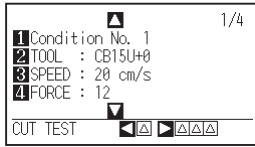

- (1) Press the POSITION (◀) key (CUT TEST).

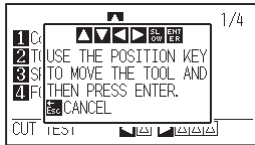

- (2) Press the POSITION (▲▼◀▶) keys to move the tool carriage to the location you wish to perform the test cutting.

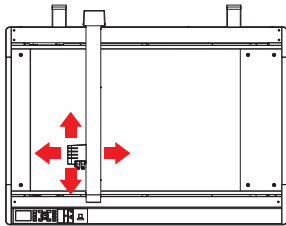

- Press the [ENTER] key.
▶ 1 cut test pattern is cut.

CAUTION

When the [ENTER] key is pressed, the tool carriage will start moving, so take care not to cut your fingers.

To make 3 cuts with set value and ± 1 of set value

- 4 Make test cutting for three pieces while Tool conditions are being set.

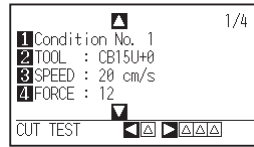

- (1) Press the POSITION (▶) key (CUT TEST).
▶ CUT TEST screen is displayed.

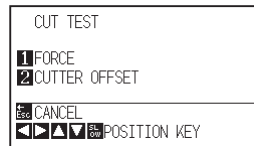

- (2) Press the POSITION (▲▼◀▶) keys to move the tool carriage to the location you wish to perform the test cutting.

- (3) Press the [1] key (FORCE).

▶ 3 cutting test patterns are cut, with current FORCE in the center, and 1 each of FORCE increased and decreased for 1.

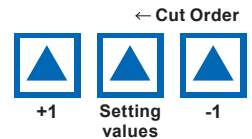

- (4) Press the [ENTER] key after completion.
▶ It will return to CUT TEST menu screen.

- (5) Press the [2] key (CUTTER OFFSET).

▶ 3 cutting test patterns are cut, with current CUTTER OFFSET in the center, and 1 each of CUTTER OFFSET increased and decreased for 1.

- (6) Press the [ENTER] key after completion.

▶ It will return to CUT TEST menu screen.

- 5 Check if the cut test is appropriate.

Confirm the cutting test results, and adjust to optimal setting. Repeat cutting test and adjustment until optimal cut is achieved.

Adjustment of Offset

Check the corners of the triangles and rectangles. See "Setting the Tool Condition" in the User's Manual (PDF) and adjust the offset value if the corner is not cut or if it is cut too much.

Adjustment for Half Cutting

Peel off the triangle area, and adjust so it cuts slightly into the backing sheet.

If the backing sheet has been cut through, either the FORCE setting is too high or the cutter-blade tip is extended too far. If the backing sheet shows only a few traces of the cutter blade, either the FORCE setting is too low or the cutter blade tip is not sufficiently extended.

See "Adjusting the Blade Length" and "Setting the Force" in the User's Manual (PDF) and adjust the settings.

Adjustment for Cutting Out

Adjust so the media is completely cut out.

If the media is not completely cut, either the FORCE setting is too low or the cutter blade tip is not sufficiently extended.

See "Adjusting the Blade Length" and "Setting the Force" in the User's Manual (PDF) and adjust the settings.

Adjustment When Using Plotting Pen

Adjust the FORCE so there will be no faint lines. To prolong the pen life, set the FORCE to the lowest setting without any faint lines. See "Setting the Force" for the FORCE setting and adjust the settings.

How to check offset

Check if the offset value is set correctly by following.



Not enough adjustment.
Increase the offset value.



Optimal offset value.



Too much adjustment.
Decrease the offset value.

Installing the Software

Install the software stored in the attached DVD-ROM into the PC that is used.

This section explains how to install the software when using a Windows 10 (64-bit) operating environment.

Note!

- Upon installation, be sure to log in Windows using an account with administrator privileges on your computer. If you have logged on using a standard user account, an "User Account Control" screen asking you to enter the administrator account password may appear.

- **Supported OS**

This software supports the following OS environments:

Windows 10 (32-bit/64-bit), Windows 8.1 (32-bit/64-bit), Windows 8 (32-bit/64-bit), Windows 7 (32-bit/64-bit)

Macintosh Mac OS X 10.11 to 10.7/ macOS 10.13 to 10.12

(Graphtec Studio also supports Mac OSX 10.6.)

- **When Using Macintosh**

Macintosh operating environments are supported by the following software.

Proceed with installation in accordance with your operating environment.

- Graphtec Studio : Software application that enables cutting data to be created through simple commands.
- Cutting Master 4 : Plug-in driver that can be directly operated from within Adobe Illustrator.
Note that Adobe Illustrator must be installed on your computer prior to use.

When checking the manual in the Macintosh operating environment, open the pertinent manual on the accompanying DVD-ROM in the following sequence: [Manuals] > [Each Language] > [Manual According to Software].

● Setup in a Windows operating environment

Launching the Start Menu

After starting up Windows, insert the [USER GUIDE & SOFTWARE DVD] supplied with the FCX4000 into your computer's DVD drive.

The below screen will appear before the Start Menu launches.

Continue with installation in accordance with the following procedures.

- 1 The start-up message of DVD drive is displayed. Click on the message.
* When setting up the DVD in the computer, this message will disappear after a few seconds.

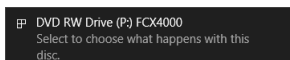

- 2 DVD operation screen is displayed.

Select the "Run MultiSetup.exe" from the DVD operation screen.

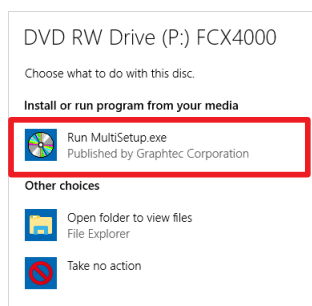

* If the DVD operation screen is not displayed, select the set DVD drive from the Explorer. Then, select the "MultiSetup.exe" in the DVD and double-click on it.

- 3 The [User Account Control] screen is displayed.
Click on [Yes] if you have logged in using an administrator account.

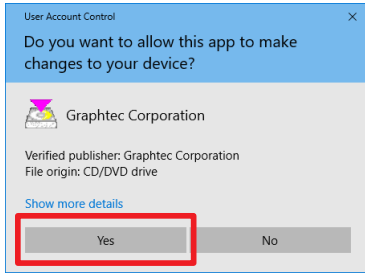

Supplement

If you have logged in using a standard user account, an "User Account Control" screen asking you to enter the administrator account password may appear. Enter the password, and then click on [Yes].

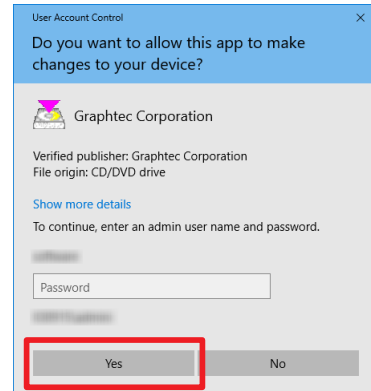

- 4 The [Start] screen will appear.
Use the "Start Menu" screen to install the software you require to use the plotter.
First-time users should proceed with installation by clicking on [Install FCX4000 Software].
Proceed with installation according to your operating environment.

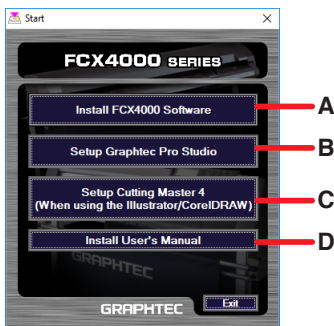

- A. Install FCX4000 Software:
Install the [Plotter Driver].
- B. Setup Graphtec Pro Studio:
"Software enabling cutting data to be created through simple commands.
Create designs and edit characters/shapes using this software."
- C. Setup Cutting Master 4:
Plug-in driver that enables simple cutting through direct operation from within Adobe Illustrator and CoreIDRAW.
Adobe Illustrator or CoreIDRAW must be installed on your computer prior to use.
- D. Install User's Manual:
Installs the User's Manual.

A. Install FCX4000 Software

If you are using the plotter for the first time, click on [Install FCX4000 Software] to install the device.
This operation will install the [Plotter Driver].



Note

Do not connect the accompanying USB cable yet. Doing so may prevent the [Plotter Driver] from being installed properly. Refer to the procedures in this User's Manual when connecting the USB cable.

Installing the [Plotter Driver]

- 1 Click on [Install FCX4000 Software].
After a while, the "Setup" screen of "Graphtec FCX4000 driver" will be displayed.
Click on [OK].

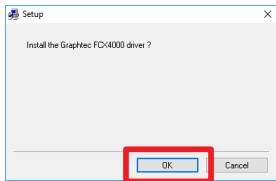

- 2 Next, check to make sure the plotter is not connected to your computer, then click on [Next].

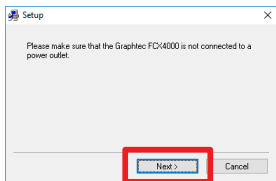

- 3 Click on [Next] again.

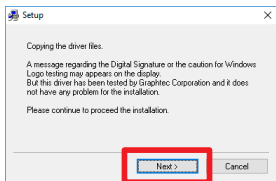

- 4 Select the [Port Name] to be used.
Here, select [USB].
Clicking on [Next] will begin the driver installation process.
USB : Selected when a USB cable is used for connection.
COM1 : Selected when an RS-232C (serial) cable is used for connection.

FILE : Selected to save outputted data (plot data) to a file.
Standard TCP/IP Port :
Connect using a LAN cable.

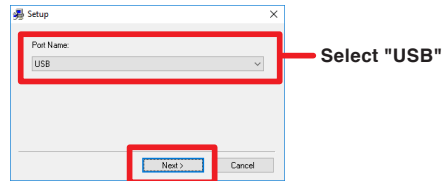

Supplement (When selecting the COM1)

To select "COM1" in "Selecting Port Name", do the installation according to the message.
(For more information about connecting the RS-232C cable, see "Connecting the computer" in User's Manual (PDF).)

Supplement (When selecting the Standard TCP/IP Port)

When selecting the "Standard TCP/IP Port" in the "Select port name", install it according to the message.
Connect the network cable after installing it. (See "Connecting to the Computer" in the User's Manual (PDF) for more information on how to connect the network cable.)
IP address depends on the network environment. Please consult your network administrator. See "Setting the Interface" in the User's Manual (PDF) for more information on how to check the IP address of this device.

- 5 The "Windows Security" screen will appear momentarily.
Click on [Install] to install the [Plotter Driver].

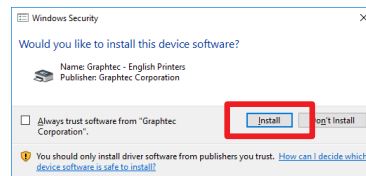

- 6 Next, the "Graphtec FCX4000 driver installation completed" screen will appear.
Click on [OK] to reboot your computer.

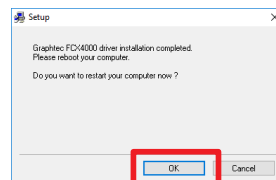

This concludes the installation of the [Plotter Driver].
After rebooting your computer, follow the below procedures to connect the USB cable.

Connecting the USB Cable

7 First, make sure that Windows 10 has been launched successfully.

Next, ensure that the plotter is turned off and then connect the USB cable supplied with the plotter to your computer.

(1) Make sure that the power switch is turned off ("O" side).

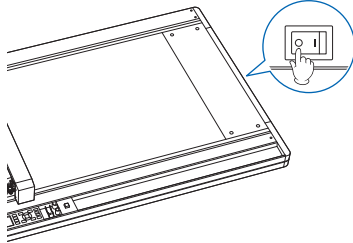

(2) Connect the power cable.

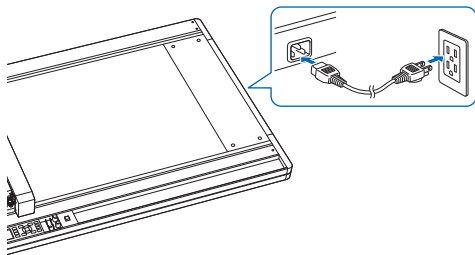

(3) Connect the USB cable.

1. Connect to your computer.

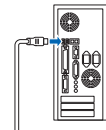

USB cable
(Accessories)

2. Connect to the Cutting Plotter.

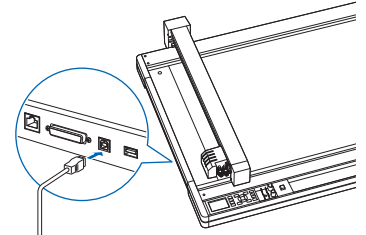

8 Turn on ("I" side) the power switch.

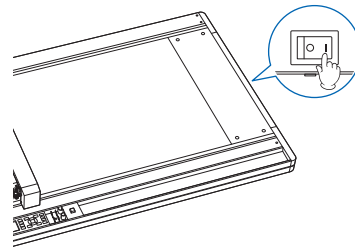

9 Installation of the device starts.

After a while, the printer icon of plotter will be added in the "Devices and Printers" screen.

* To display the "Devices and Printers" screen, display the "Control Panel" screen from the Start menu and then click on the [Devices and Printers] in the [Hardware and Sound].

This concludes the installation of the driver software.

Next, please install the software applications.

Install the software in accordance with your operating environment.

B. Setup Graphtec Pro Studio

Please download the User's Manual separately from our website and perform the setup.

C. Set Up Cutting Master 4

Please download the User's Manual separately from our website and perform the setup.

D. Install User's Manual

Follow the below procedures to install the User's Manual (pdf format).

PDF browsing software must be installed on your computer in order to read the manual.



Installing "User's Manual"

- 1 Click on [Install User's Manual].
The "FCX4000 User's Manual Setup" screen will appear momentarily.
Click on [Next].

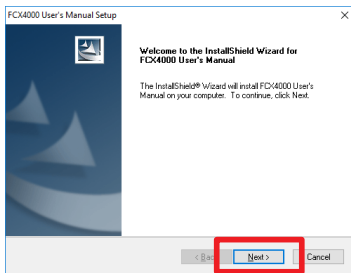

- 2 When this screen appears, click on [Finish].

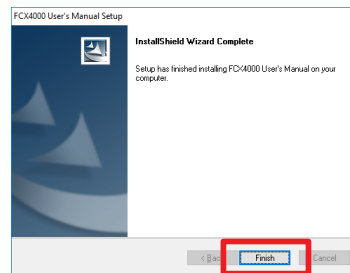

This concludes the installation of the [User's Manual].

The newly-installed [User's Manual] will be registered under your Windows Start Menu.

- **Setup in a Macintosh operating environment**

A. Set Up Cutting Master 4

Please download the User's Manual separately from our website and perform the setup.

B. Setup Graphtec Studio

Please download the User's Manual separately from our website and perform the setup.